

Quick Start

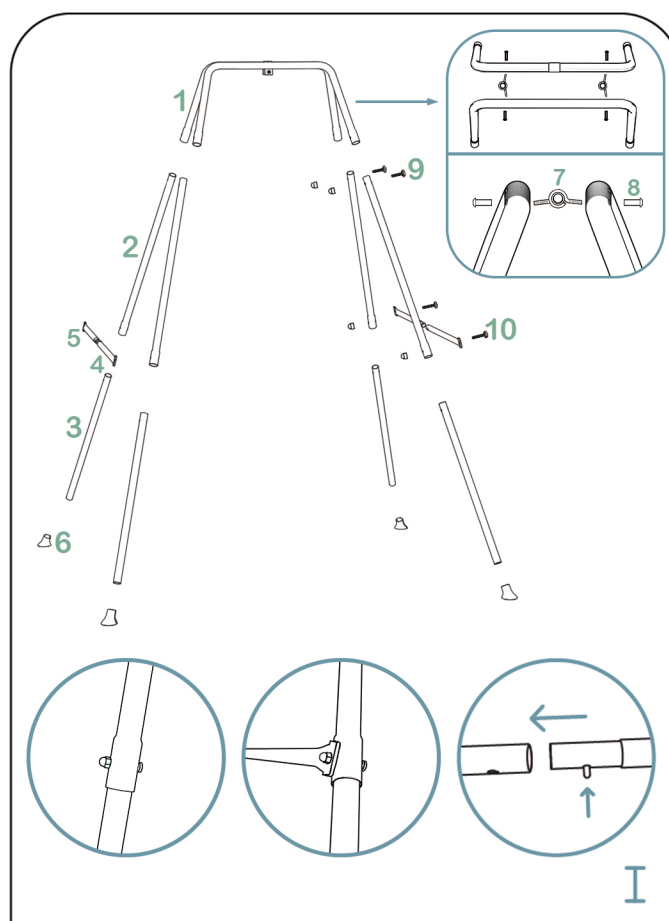

Check out the installation video on YouTube



Connect all frame parts together following the number and graphic description above

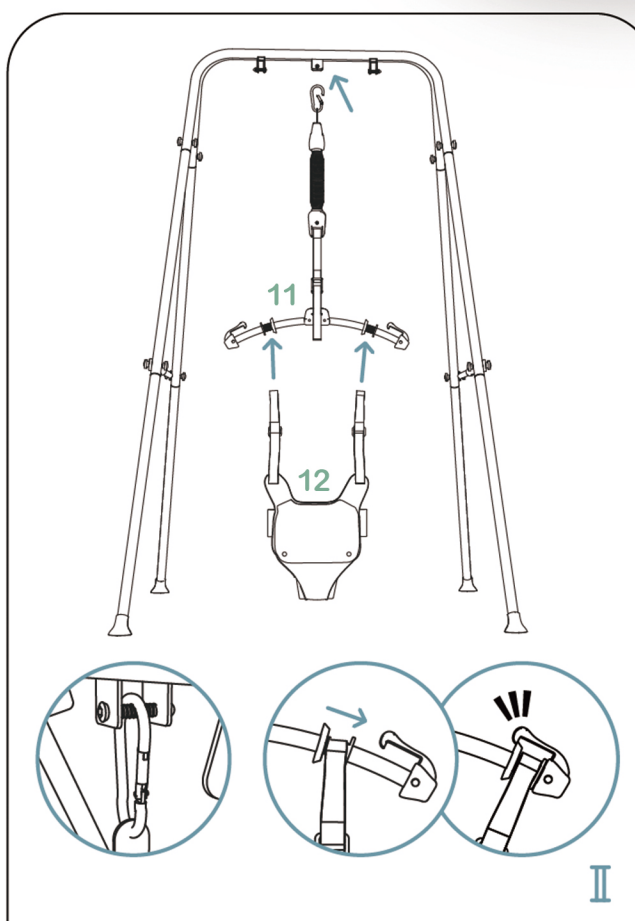

Install the spring and balance bar, hang the webbing on both ends of the balance bar to ensure that it is locked

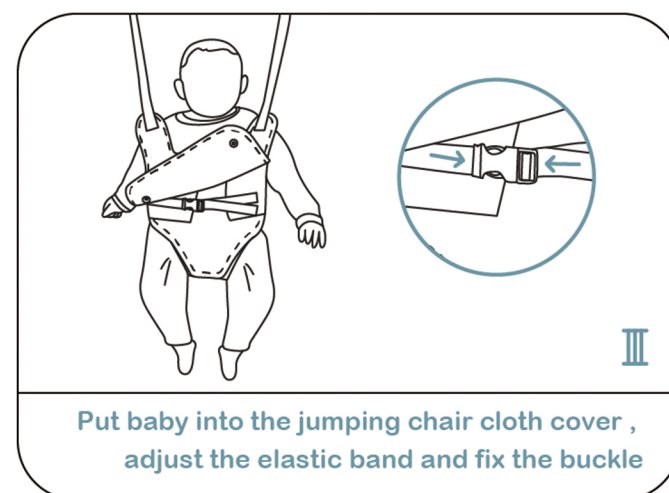

Put baby into the jumping chair cloth cover, adjust the elastic band and fix the buckle

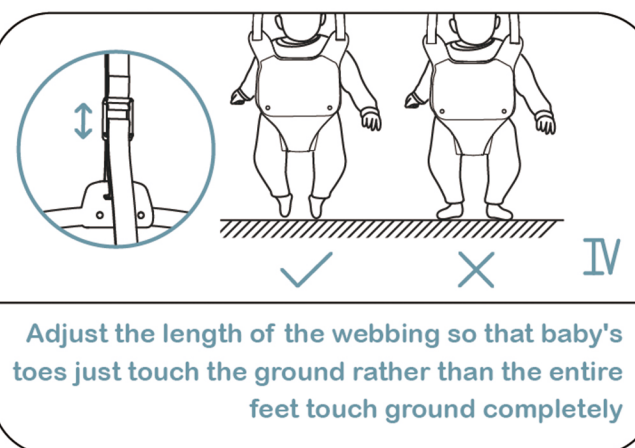

Adjust the length of the webbing so that baby's toes just touch the ground rather than the entire feet touch ground completely



**BABY
JUMPER
WITH
STAND**

SALE SUPPORT

Dear Amazon Customer :

Thank you for your order on Amazon. Our purpose is providing the best quality products and services.

If you have any questions about the product, please contact us directly via Amazon or E-mail. We will solve for you in time.

Hope you have a happy shopping experience from our store.



✉ Talecogear@gmail.com

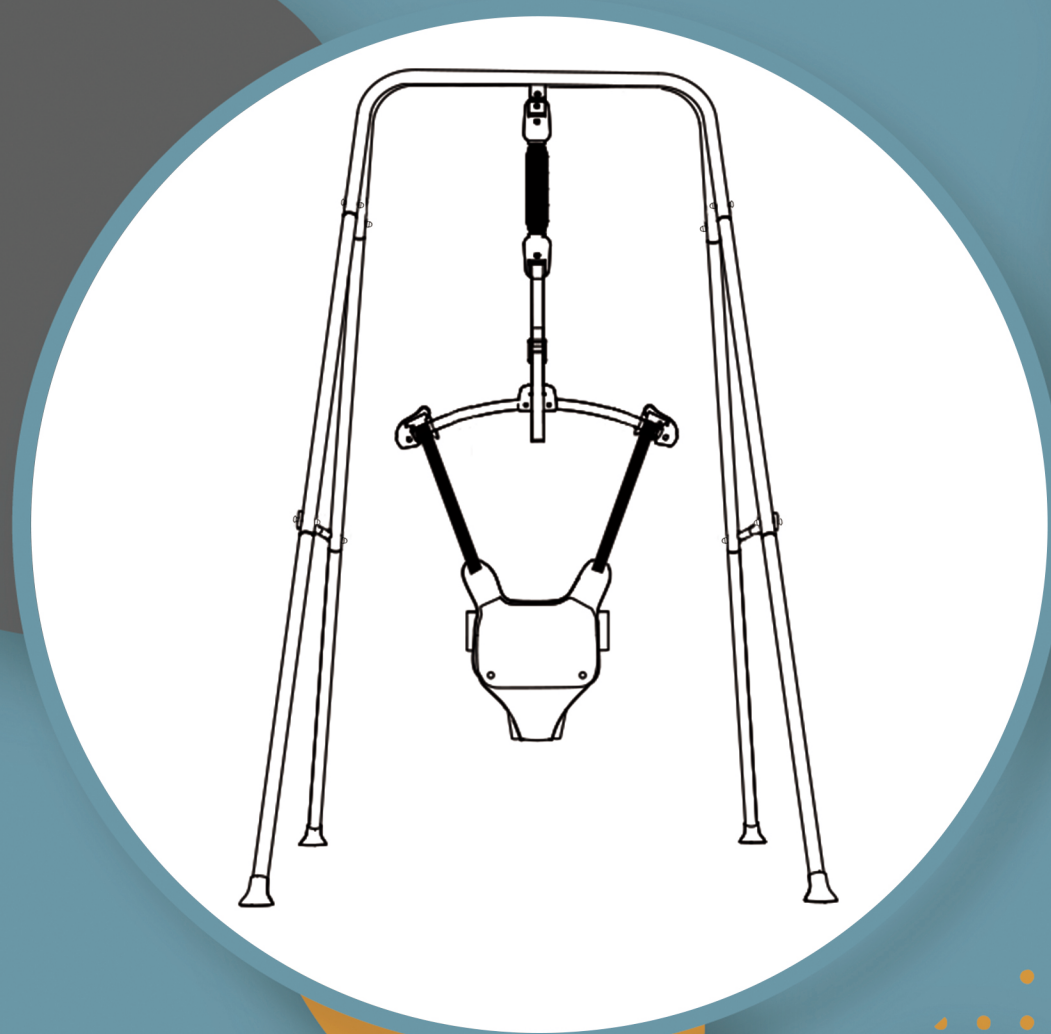

User Manual



Parts List

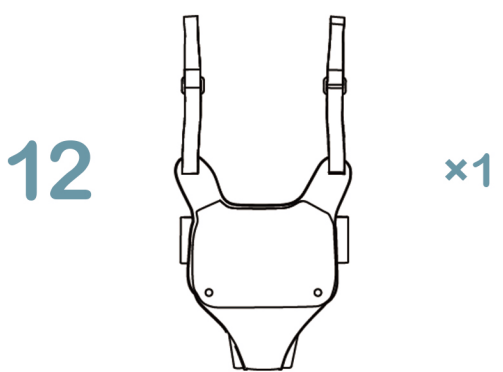
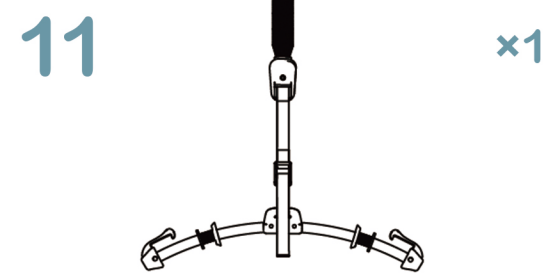
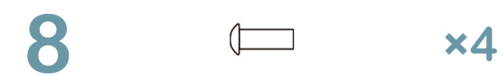
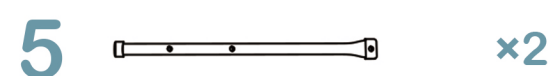
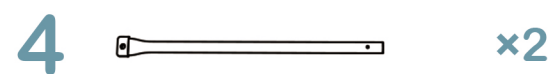
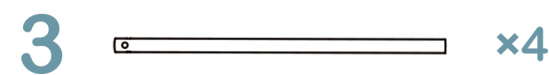
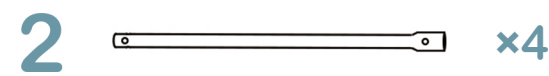
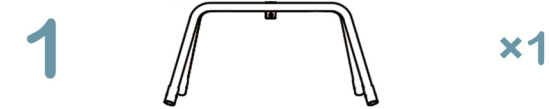
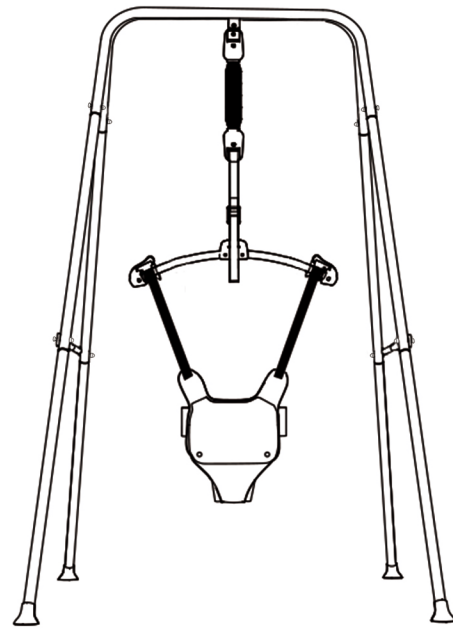

Product Features



High-Strength Spring
Built-in Heavy Duty
Nylon Webbing



Anti-Reverse
Screw Cap



Non-slip
Rubber Feet

Wider shoulders are safer
and more comfortable



Pure cotton fabric to
protect baby's delicate skin



Add soft mesh cloth on both
sides of crotch , More
breathable and prevents
o-legs



Warning



Please observe the following precautions and instructions before using this product to avoid danger caused by improper use.

- ① Suitable for babies who can support their head (6 months to 2 years old) and weigh less than 35 pounds (16 kg).
- ② Adult supervision required! Never leave baby alone when using jumper.
- ③ Do not give baby food or drink while using jumper.
- ④ Do not use in uneven places to avoid falling.
- ⑤ Please make sure baby has been put well into the baby chair cloth cover before using!
- ⑥ Before using, please check all parts of the bracket which are firmly connected to ensure safety.